

INSTRUCTION MANUAL
FOR

PNEUMATIC LEVEL SENSOR

MODEL : FP510



Issued Dec. 25, 2001



NOHKEN INC.

MUST BE READ BEFORE USING

- This manual is for explosion-proof specifications. Read the other manuals for standard specifications.
- This manual describes the handling, inspection and adjustment of the sensor. Read and understand this manual before installation.
- Any documents and/or directions from Nohken and the agents aside from this manual shall be preceded.
- Save this manual to refer when you need.
- If you have any questions or comments about this manual and/or the sensor, ask Nohken's sales office written on the front cover.

Signal words in this manual means as follows:

 WARNING	Indicates a potentially hazardous situation which, if not avoided, could result in death or serious injury.
 CAUTION	Indicates an potentially hazardous situation which, if not avoided, may result in minor or moderate injury.
 NOTE	Indicates exceptional cases and attention for handling of sensors.

	Indicates prohibition. The explanation with this manual should always be followed.
	Indicates directions. The explanation with this manual should always be followed.

⚠ WARNING

• Do not modify or disassemble the equipment. Otherwise, the ignition to an explosive gas may occur.



• Before opening the cover, make sure that the terminal box is cooled down. Otherwise, the ignition to an explosive gas may occur.



⚠ CAUTIONS

• The allowable hazardous location is Zone 1 and 2. Do not install in Zone 0.



• This sensor gives the properties of the flameproofness by strength of housing and the gap and length of path. Therefore, do not damage the housing, joints and the screwed-in parts. Otherwise, the flame-proofness can not be protected.









• For inspection, adjustment and maintenance, any disassembly to joints is prohibited.



• Secure bolts and screws by using spring washers against looseness. Otherwise, the flameproofness can not be protected.



⚠ CAUTIONS

<ul style="list-style-type: none">• Adjustment, inspection and maintenance shall be done by the skilled engineer.	
<ul style="list-style-type: none">• Inspection and maintenance shall be in accordance with the Plant Electrical Equipment Flame-proof guide book published by RIIS and all local codes.	
<ul style="list-style-type: none">• Turn off the power supply immediately when abnormal conditions are encountered, such smoke, disagree smell and unusual noise.	
<ul style="list-style-type: none">• Make sure that the wiring is correct. Otherwise, the sensors may be damaged, ignited or cause an electric shock.	
<ul style="list-style-type: none">• For grounding, we recommend to use the earth terminal in the housing to prevent from deterioration by atmospheric condition.	
<ul style="list-style-type: none">• Use the specified color for grounding to identify easily. For example, we recommend to use green.	

▲NOTE

• Do not give strong shocks to the sensor. Dropping, throwing, striking and dragging the sensor, for example, are to cause strong shocks and damage the sensor.



• The specifications such as ambient temperature, maximum voltage and the power rating shall meet the conditions. Otherwise, the sensor may cause malfunction, damage, ignition, electric shock and injury. Read and check the clause of specification in the manual or specification sheets.



• Operating test shall be conducted before practical use. If malfunction occurs and the accident is predicted, the remedy shall be administrated by using another sensor with different operating principle in parallel.



• When connecting inductive load or the lamp load to the microswitch output contact. To prevent overvoltage and overcurrent, provide a protective circuit to the load. Otherwise, the contact may be damaged.



• Check the chemical compatibility with the material you want to use. A minor corrosion to the float and the thin thickness part may be chemically effected.



INTRODUCTION

- A. This manual specifies standard specifications of this product.
Some specifications may be different from your product if you order the custom-made product.
- B. A variety of specifications are available to meet your process conditions, such as installation conditions, chemical compatibility, and so on.
We are glad to offer suggestions to assist your decision.
- C. If you have any questions or comments for the contents of this manual, ask Nohken's sales office written on the front cover.
- D. Nohken Inc. pursues a policy of continuing improvement in design and performance of this product. We will supply the alternative parts or complete new products required to repair or replacement.
- E. Specifications are subject to change without any obligation on the part of the manufacturer.

WARRANTY & DISCLAIMER

- A. Nohken Inc. warrants this product against defects in design, material and workmanship
for a period of 1 (one) year from the date of original factory shipment.
- B. If defects occurs during the above-mentioned warranty period, Nohken will, at its option, replace or recondition the product without charge. This shall constitute the exclusive remedy for breach of warranty.
- C. Nohken Inc. makes no warranty with respect to:
 - C-a Failure not to comply with instructions of this manual.
 - C-b Failure or damage due to improper installation, wiring, operation, maintenance, inspection and storing.
 - C-c Product which has been in any way repaired, altered or tampered with by others.
 - C-d Product repaired or modified by using undesignated parts, subassemblies and materials.
 - C-e Direct incidental or consequential damages or losses or expenses resulting from any defective product or the use of any product.
 - C-f Objective of the sensor is clearly specified in chapter PURPOSE OF USE.
 - C-g Inevitable accident such as acts of God, force majeure, radioactive contamination and so on.

THIS WARRANTY IS IN LIEU OF AND EXCLUDES ALL OTHER WARRANTIES OF MERCHANTABILITY OR FITNESS FOR A PARTICULAR PURPOSE.

TABLE OF CONTENTS

1. HANDLING OF EXPLOSION-PROOF	... 2	7. WIRING	... 7
1.1 EXPLOSION-PROOF SPECIFICATIONS	... 2	7.1 PREPARATION	... 7
1.2 INDICATION OF EXPLOSION-PROOF	... 2	7.2 CABLE INLET	... 8
1.3 ENVIRONMENT CONDITIONS	... 2	7.3 WIRING	... 8
1.4 EXTERNAL WIRING	... 2	7.4 OPERATIONAL CHECK	... 9
1.5 REPAIR AND REPLACEMENT	... 2	7.5 COVER INSTALLATION	... 9
2. PURPOSE OF USE	... 3	8. MAINTENANCE & INSPECTION	... 9
3. DESCRIPTION	... 3	8.1 REMOVING	... 9
3.1 PRODUCT DESCRIPTION	... 3	8.2 MAINTENANCE & INSPECTION	... 9
3.2 PRINCIPLE OF OPERATION	... 3	8.3 RE-INSTALLATION	... 10
4. SPECIFICATIONS	... 3	8.4 WIRING	... 10
4.1 OPERATING CHARACTERISTICS	... 3	9. STORAGE	... 10
4.2 ELECTRICAL CHARACTERISTICS	... 3	10. TROUBLESHOOTING	... 11
4.3 MECHANICAL CHARACTERISTICS	... 3	11. GLOSSARY	... 11
4.4 AMBIENT CHARACTERISTICS	... 4		
4.5 CONSTRUCTIONS	... 4		
4.6 MATERIALS	... 4		
4.7 CABLE INLET	... 4		
4.8 INSTALLATION	... 4		
5. HANDLING NOTES	... 4		
6. INSTALLATION	... 5		
6.1 UNPACKING	... 6		
6.2 INSTALLATION	... 6		
6.3 AIR SUPPLYING UNIT	... 7		

1. HANDLING OF EXPLOSION-PROOF

1. 1 EXPLOSION-PROOF SPECIFICATIONS

The FP is of flame-proof construction, and has the following specification:

Model name	Type designation	Approval type number	Explosion construction and applicable gas
FP510	FP510 (FP511)	No. 49406	d2G4

1. 2 INDICATION OF EXPLOSION-PROOF

All technical information such as model name, power supply, manufacturing No., manufacturing date, approval No. and precautions for handling are specified on the terminal box.

1. 3 ENVIRONMENT CONDITIONS

The FP can be installed in hazardous locations containing the gas atmosphere which the FP is certified to be explosion-proof in.

The allowable humidity range and temperature range at the installation site are as follows:

Humidity : 85% RH Max.

Temperature : 0 ~ 60 °C

The temperature range of each electrode is specified in section 4. SPECIFICATIONS.

1. 4 EXTERNAL WIRING

To protect the flame propagation through any joint or structural openings in the enclosure, gap width of all joint is specified by rules. Since the FP is the flame-proof type, open the cover only for electrical connections. Any disassembly to joints is prohibited.

1. 5 REPAIR AND REPLACEMENT

As a rule, all repair and replacement of explosion-proof version shall conducted only to recover the original state's factory. To alter specifications, make any modification or disassembly on site is strictly prohibited. That's why in case of replacement of diaphragm and adjustment of microswitch position, return the FP of Nohken.

2. PURPOSE OF USE

The FP510 is used for liquid level detection such as water, oil, chemicals and so on. It is used for taking out the control signal from alarms or pumps. Do not use in any other applications.

3. DESCRIPTION

3. 1 PRODUCT DESCRIPTION

The FP is a diaphragm actuated switch. To operate, the FP is installed on the tank with G1" thread. The microswitch (*) in the FP is actuated by receiving the liquid head pressure (*) in the detecting pipe beneath the diaphragm.

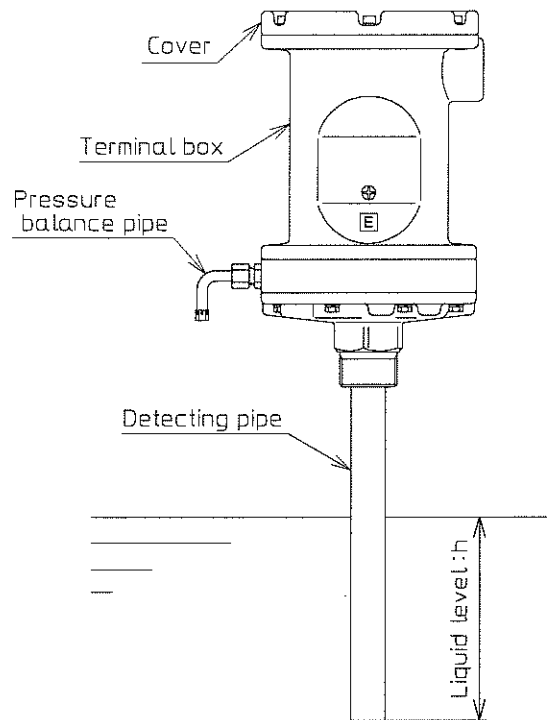

3. 2 PRINCIPLE OF OPERATION

The FP is installed vertically on the container top. As the liquid rises, the detecting pipe connected to the FP contacts with liquid. By compression of a captive air column in this pipe, the microswitch operates at the specified position.

4. SPECIFICATIONS

4. 1 OPERATING CHARACTERISTICS

- ① Application : Open type (Max. depth is 3m)
 - ② Switch operating point : 60 ± 10 mm
 - ③ Switch release point : 40 ± 15 mm
- (By using 1/2B L=300 mm pipe)

4. 2 ELECTRICAL CHARACTERISTICS

- ① Contact capacity : 250 V 10 A AC
(Resistive load) 250 V 0.2 A DC
- ② Min. load : 5 V 160 mA DC
- ③ Life expectancy : 3×10^5 Operation Min.

4. 3 MECHANICAL CHARACTERISTICS

- ① Ambient pressure of diaphragm : 0 ~ 100 kPa
- ② Allowable impact : 100 m/s^2

*: See section 11 for the word explanation.

4. 4 AMBIENT CONDITIONS

- ① Ambient temperature : 0 ~ 60 °C
- ② Liquid temperature : 0 ~ 70 °C

4. 5 CONSTRUCTIONS

- ① Terminal box protection (*) : IP53
- ② Flame-proof construction (*) : d2G4

4. 6 MATERIALS

- ① Terminal box : AC4A
- ② Cover : AC4A
- ③ Chamber : AC4A
- ④ Diaphragm (*) : CR

4. 7 CABLE INLET : (FP510) G 3/4

(FP511) G 3/4 Flameproof packing type, Cable diameter size $\phi 11.0 \sim \phi 15.9$

4. 8 INSTALLATION

- ① For container : G1
- ② For pipe coupling : Rc 1/2

CAUTIONS

If the relay is inductive load or lamp load, connect protecting circuit to the load side to avoid overvoltage or overcurrent. If exceeds maximum value, the microswitch shall be damage.

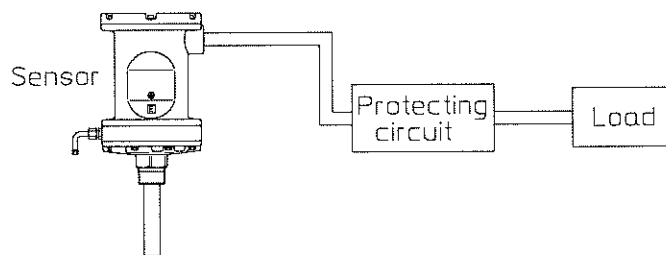

5. HANDLING NOTES

Cautions shall be taken as follows. If not the sensor shall be damaged.

- 5. 1 Avoid physical shock. Dropping, throwing or bumping shall damage the sensor.

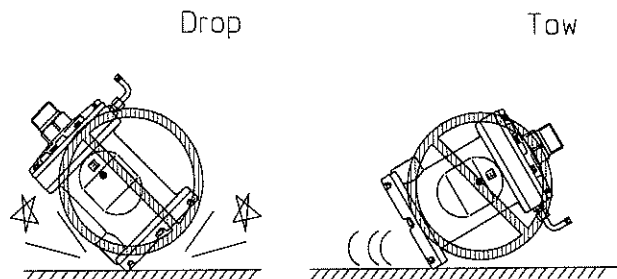

*:See section 11 for the word explanation.

5. 2 When painting the sensor, do not paint on the nameplate to keep the indication of serial number for future reference when ordering parts. Avoid painting on the thread.

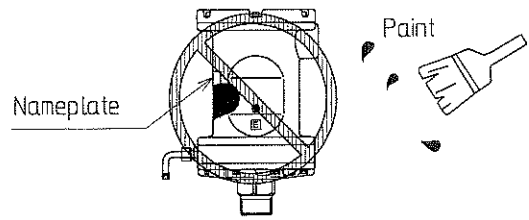

5. 3 Do not use or store in a corrosive atmosphere (NH₃, SO₂, Cl₂, etc.). Internal circuit shall be corroded and conduction failure may occur.

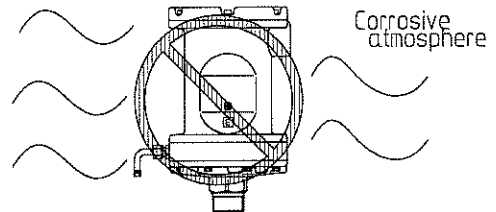

5. 4 Protect the sensor from dust, dirt and foreign matters. Otherwise the diaphragm in the sensor may be damaged.

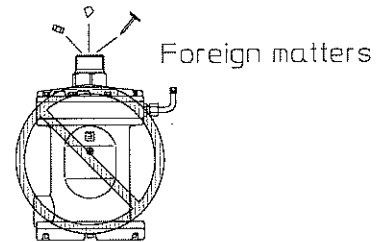

5. 5 Do not locate near agitator or liquid inlets/outlets. The operation will be unstable.

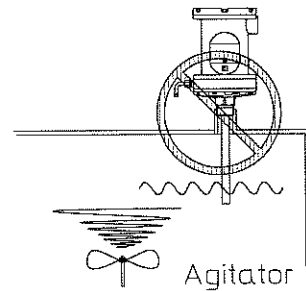

5. 6 Do not install the FP on the pressurized container. Despite the liquid level change, the diaphragm is always receiving the pressure.

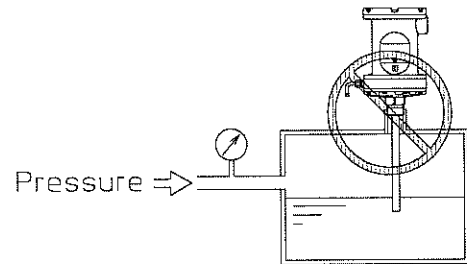

5. 7 When low level detection, the operating point rises. This is because the air inside the pipe dissolved into the liquid.

6. INSTALLATION

⚠ WARNING

The allowable hazardous location(*) is Zone 1(*) and 2 (*).
Do not install in Zone 0(*).

*:See section 11 for the word explanation.

6. 1 UNPACKING

6. 1. 1 Avoid physical shock. Dropping, throwing or bumping shall damage the sensor.

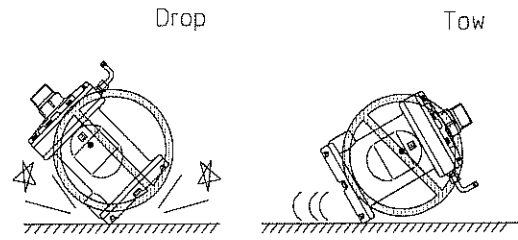

6. 1. 2 Make sure the products you ordered is correct. If not, contact Nohken.

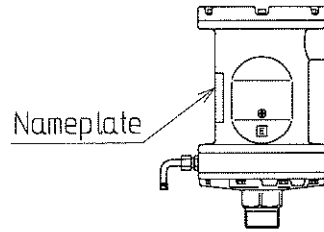

6. 1. 3 Protect the sensor from dust, dirt and foreign matters. Otherwise the diaphragm in the sensor may be damaged.

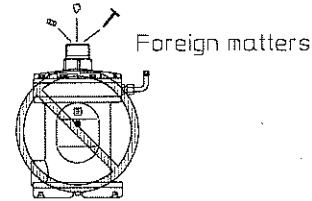

6. 2 INSTALLATION

6. 2. 1 Do not locate near agitator or liquid inlets/outlets. The operation will be unstable. If inevitable, use stilling tube(*).

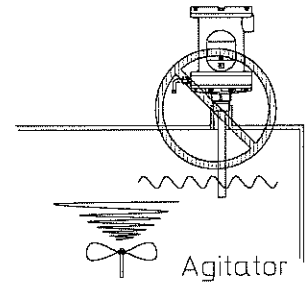

6. 2. 2 When installing, wrench the hexagon part. Do not wrench on the terminal box. Make sure the FP is mounted in horizontal alignment.

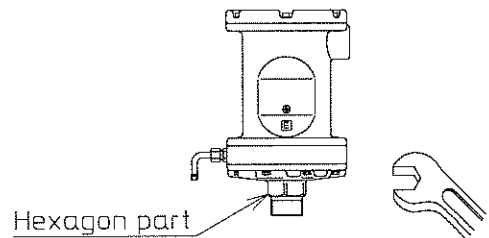

6. 2. 3 Do not use or store in a corrosive atmosphere (NH_3 , SO_2 , Cl_2 , etc.). Internal circuit shall be corroded and conduction failure may occur.

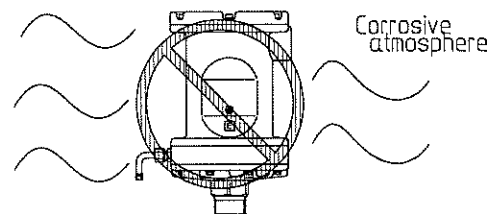

6. 2. 4 Do not install the FP on the pressurized container. Despite the liquid level change, the diaphragm is always receiving the pressure.

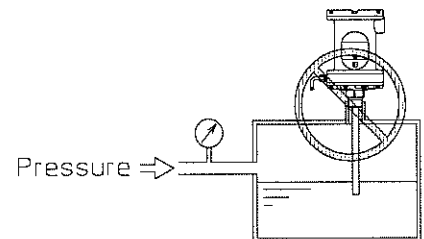

*:See section 11 for the word explanation.

6.2.5 Pipe coupling shall be airtight by applying a sealing compound in paste form. Do not use a seal tape.

6.3 AIR SUPPLYING UNIT

When low level detection, the operating point rises. This is because the air inside the pipe is dissolved into the liquid. We recommend to use the air supplying unit to ventilate. It is also ideal for highly sticky liquids, liquids with many suspended solids and corrosive liquids.

Recommended air source and switch points are shown below.

Flow rate of air : 0 ~ 0.3 l/min

Air pressure : 0 ~ 50 kPa

Switch operating point : 40 ± 10 mm

Switch release point : 30 ± 15 mm

(By using 1/2B L=300 mm pipe)

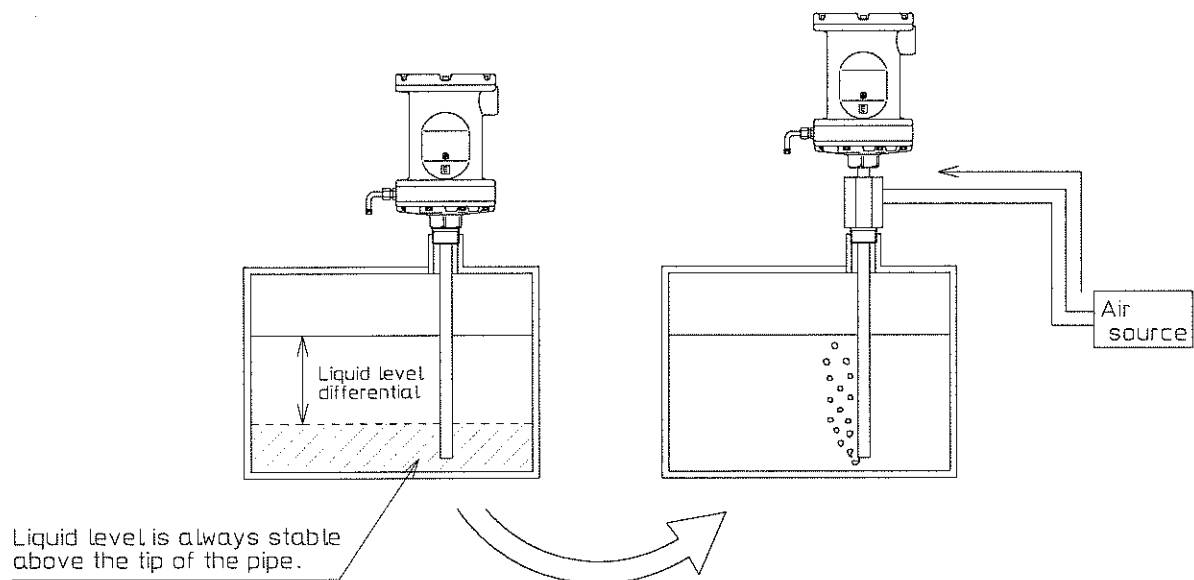

7. WIRING

7.1 PREPARATION

Wiring shall be in accordance with Technical Recommendations RIIS-TR-79-1 and RIIS-TR-94-2 issued by Research Institute of Industrial Safety, Japanese Ministry of Labor.

▲WARNING

In hazardous areas, Do not remove the terminal box cover and connect the cable until atmosphere is to be safe and the power supply is turned off.

7. 2 CABLE INLET

Cable inlet is G3/4 (JIS B 0202). The cable must be led into the terminal box housing through the pressure-tight screw-thread coupling.

7. 3 WIRING

7. 3. 1 Use wire in conjunction with JIS C 3307, 600V IV or equivalent.

7. 3. 2 Use pressure-tight cable conduit in conjunction with JIS C 8305.

7. 3. 3 Provide the sealing fitting (*) on the flexible fitting (*) near the cable inlet to seal (*) exclusive gas.

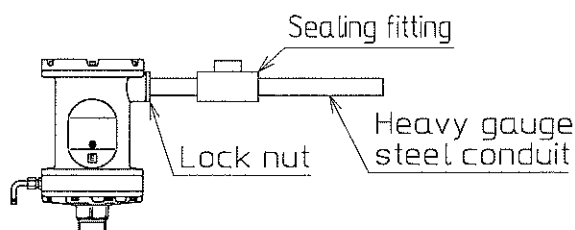

7. 3. 4 Use the flame-proof approved parts for wiring.

7. 3. 5 Secure each coupling, at least 5 turns, with the lock nut. Do not loosen any connection to avoid ignition.

7. 3. 6 The earth terminal in the terminal box or the external earth bolt shall be grounded, on the conditions of less than 100 Ω .

⚠ CAUTION

- ① For grounding, we recommend to use the earth terminal in the terminal box to prevent from deterioration by atmospheric condition.
- ② Use the specified color for grounding to identify easily.
For example, we recommend to use green.

7. 3. 7 Terminal screw is M4. Tighten it by using the phillips blade driver.
The terminal plate of the FP is shown below.

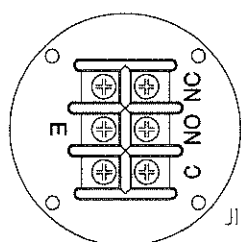

JIS class D ground
Max. 100 Ω

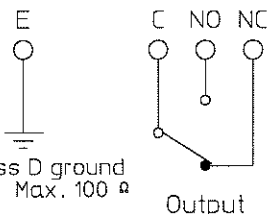

Solderless tag with
insulated sleeve for M4

Spring washer

⚠ WARNING

Use the spring washer to avoid loosening. Tighten them to preserve flame-proof construction.

*: See section 11 for the word explanation.

7. 4 OPERATIONAL CHECK

Before operating your plant, check the sensor operation primary. If unsuccessful, ask Nohken service department.

7. 5 COVER INSTALLATION

The cover is designed anti-rotation clamp structure. After the electrical connections, tighten the cover and clamp it with anti-rotation bolt by the hex wrench (size 3).

⚠ WARNING

- ① Use the spring washer to avoid loosening. Tighten them to preserve flame-proof construction.
- ② When tighten the cover, do not remove the O-ring to protect the flame propagation through this joint (*).

8. MAINTENANCE & INSPECTION

Remove the sensor from the container during overhaul period of your plant.

⚠ WARNING

- ① Maintenance shall be done by the skilled engineer.
- ② It shall be in accordance with the Plant Electrical Equipment Flame-proof guide book published by Research Institute of Industrial Safety and all local codes.
- ③ Do not damage any joint or structural openings of the terminal box.
To protect the flame propagation, gap width and length of all joint is specified by rules.

8. 1 REMOVING

8. 1. 1 Wiring shall be in accordance with Technical Recommendations RIIS-TR-79-1 and RIIS-TR-94-2 issued by Research institute of Industrial Safety, Japanese Ministry of labor.

⚠ WARNING

In hazardous areas, Do not remove the terminal box cover and connect the cable until atmosphere is to be safe and the power supply is turned off.

8. 1. 2 Remove the cover by using the hex wrench and disconnect all wiring.

8. 1. 3 Remove the sensor from the container by wrenching the hexagon part.

8. 2 MAINTENANCE & INSPECTION

As a rule, all repair and replacement of explosion-proof version shall conducted only to recover the original state's factory. To alter specifications, make any modification or disassembly on site is strictly prohibited. That's why in case of replacement of diaphragm and adjustment of microswitch position, return the FP to Nohken.

*: See section 11 for the word explanation.

8. 2. 1 Tighten loose screws. Check for damaged parts.

8. 2. 2 Clean dust, dirt and moisture from terminal box.

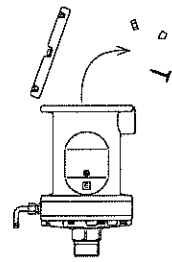

Remove dust, dirt, metallic substances, etc.

8. 2. 3 Check for corrosion due to condensation, gas and vapor on terminals and wires.

8. 3 RE-INSTALLATION

Reinstall the sensor to the container. Refer to section 6. 2 INSTALLATION.

8. 4 WIRING

Reconnect the cable. Refer to section 7 WIRING.

9. STORAGE

The sensor shall be stored under the following conditions when it is not used for a long time.

9. 1 Do not use or store in a corrosive atmosphere (NH_3 , SO_2 , Cl_2 , etc.). Internal circuit shall be corroded and conduction failure may occur.

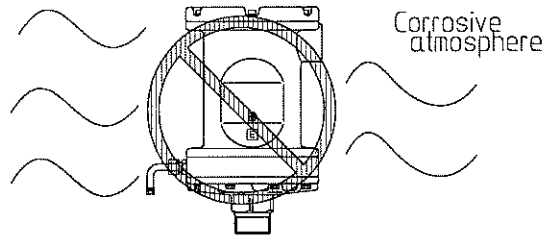

9. 2 Lead wire egress is non-dripproof. Keep the lead wire out of water. Water penetration may cause the bad insulation.

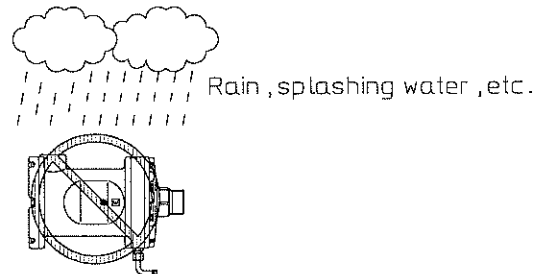

9. 3 Protect the sensor from dust, dirt and foreign matters. Otherwise the diaphragm in the sensor may be damaged.

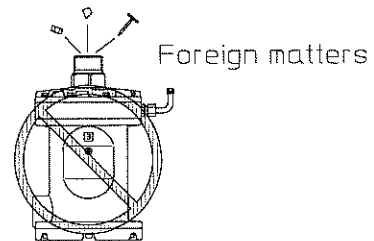

REFERENCE

Keep the sensor in sealed plastic bags with desiccant or other moisture-proof packing.

10. TROUBLESHOOTING

10. 1 NO CONTACT OUTPUT WITH LEVEL CHANGE

- Check for miswiring or loose wiring. ⇒ Wire correctly. See section 7.
- Sealing of the connection between the detecting pipe and chamber of level switch is not. ⇒ Pipe coupling shall be airtight by applying a sealing in paste form. See section 6.
- Detecting pipe or pressure balance pipe is clogged by sticking adhesives. ⇒ Clean it regularly. Use the air supplying unit. See section 6.
- Electrical contact is at fault due to low-load or overload. ⇒ Replace the microswitch and check the load. Provide the protective circuit if necessary. See section 4.

10. 2 CONTACT ALWAYS OUTPUTS WITHOUT LEVEL CHANGE

- Miswiring or short-circuit wiring. ⇒ Wire correctly. See section 7.
- Detecting pipe or pressure balance pipe is clogged by sticking adhesives ⇒ Clean it regularly. Use the air supplying unit. See section 6.
- Microswitch is broken. ⇒ Replace it check the load. Provide the protective circuit if necessary. See section 4.

10. 3 CONTACT OUTPUTS AT UNDESIREED POSITION

- The tip of the pipe is always under measuring object. ⇒ Use the air supplying unit. See section 6.
- Detecting pipe or pressure balance pipe is clogged by sticking adhesives ⇒ Clean it regularly. Use the air supplying unit. See section 6.

For replacement of the microswitch, contact Nohken.

11. GLOSSARY

- Microswitch : Miniature switch which consists of a precisely spaced snap-action mechanism with a prescribed force.
- Liquid head pressure : When liquid specific gravity(γ) is stable, liquid level(h) is proportional to the liquid pressure(P). This relation can be expressed as $P=\gamma h$.
- Terminal box protection : International protection in conjunction with IEC 529 to preserve dust and water penetration.

Flame-proof construction: This type is an enclosed construction for electrical equipment as a whole or parts of electrical equipment which will withstand an internal explosion explosive gas, without suffering damage and without communicating the internal flammation to the external explosive gas through any joints or structural openings in the enclosure.

Diaphragm : Rubber to receive liquid head pressure in the detecting pipe.

Hazardous location : the location exists flammable gas or may cause explosion.

Hazardous area Zone 0 : Where hazardous atmosphere is or may be continuously present and in which the concentration of the explosive gas is continuously or for long periods equal to, or more than, the lower explosion limits.

Zone 1 : Where hazardous atmosphere is likely to occur under normal conditions.

Zone 2 : Where hazardous atmosphere is likely to occur under abnormal conditions.

Stilling tube : To prevent the FP from the liquid turbulence or stream.

Sealing fitting : Piping parts which is potted flame retardants to seal exclusive gas.

Flexible fitting : Flexible piping parts for connecting with the sensor and conduit.

Seal : Compound to make a flame-resistant.

Joint : Junction surface between cover and terminal box and terminal box and terminal box and terminal plate.

NOHKEN INC.

HEAD OFFICE : 15-29, Hiroshiba-cho, Suita-city, Osaka 564-0052, Japan.

TEL:06-6386-8141 FAX:06-6386-8140

TOKYO BRANCH OFFICE : 67, Kandasakumagashi, Chiyoda-ku, Tokyo 101-0026, Japan.

TEL:03-5835-3311 FAX:03-5835-3316

NAGOYA OFFICE : 3-10-17, Uchiyama, Chikusa-ku, Nagoya-city, Aichi 464-0075, Japan.

TEL:052-731-5751 FAX:052-731-5780

KYUSHU OFFICE : 14-1, 2-chome, Asano, Kokurakita-ku, Kitakyushu-city, Fukuoka 802-0001, Japan.

TEL:093-521-9830 FAX:093-521-9834